

COMMON

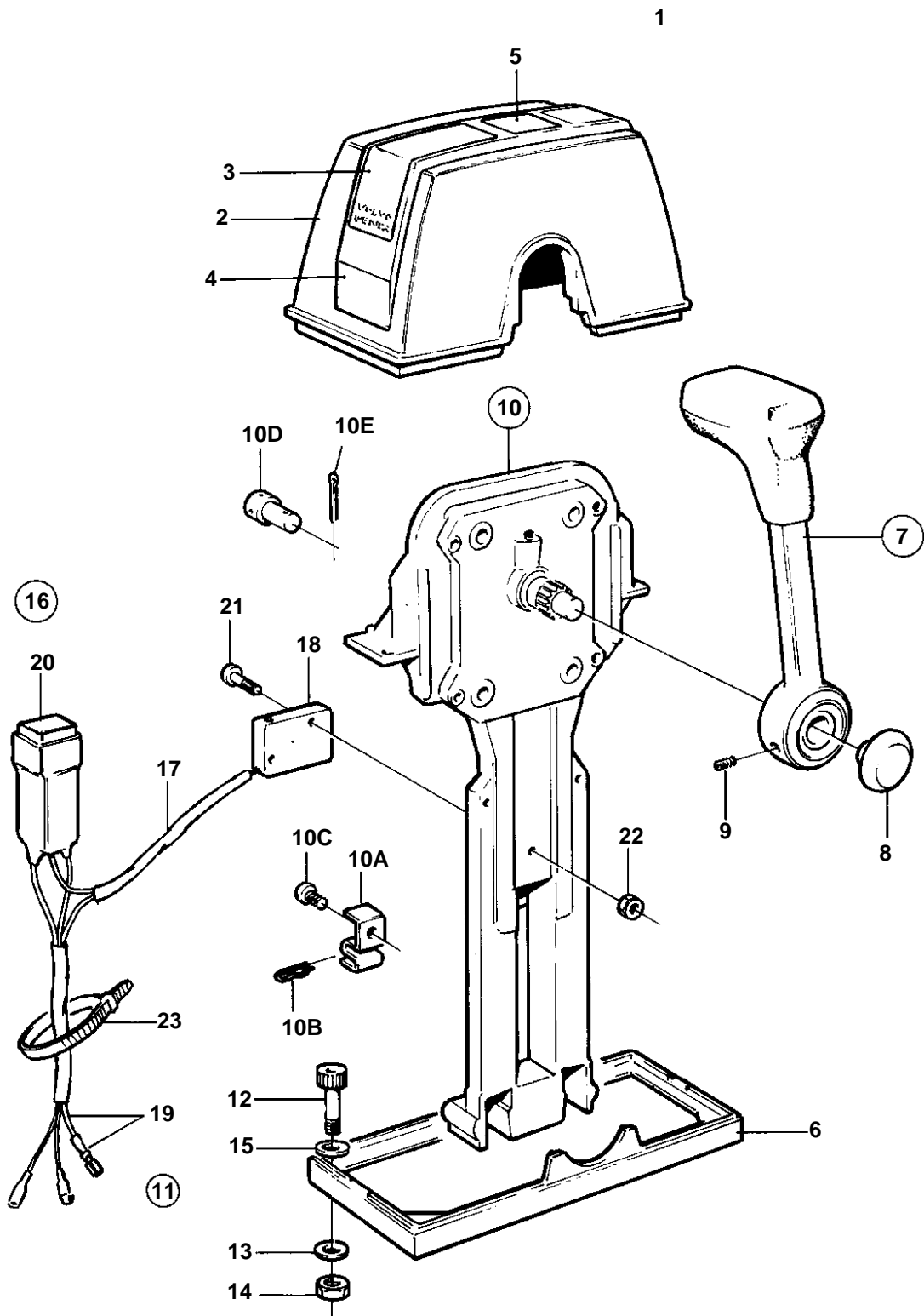

15094

COMMON

REF	PART NO.	QTY	DESCRIPTION	SEE SEC.	NOTES
1	853169	1	Mounting kit		For twin installation.
2	851881	1	• Cover		
3	851895	2	• • Decal		
4		1	• • Cover plate		
5	851897	1	• • Decal		
6	839479	1	• • Plate		
7	852347	2	• Lever		
8		2	• • Push button	266	Included in complete handle.
9		2	• • Screw		Included in complete handle.
10	851600	2	• Control		
10A	853423	2	• • Retainer		
10B	852924	2	• • Clip		
10C	839664	2	• • Screw		
10D	839638	2	• • Cube		
10E	17253	2	• • Cotter pin		
11		1	• Screw kit		
12	947671	4	• • Allen head screw		
13	960138	4	• • Washer		
14	955780	4	• • Nut		
15	940090	4	• • Washer		
16	855352	2	Neutral posit contac		
17	839619	2	• Cable kit		
18	850200	2	• • Switch		
19		X	• • Cables and terminals		SE GROUP 30
20	876037	2	• Relay kit		
21	946177	4	• Screw		
22	947536	4	• Nut		
23	948211	X	• Strip clamp		